

TORINO E

TRINCIA LATERALE PROFESSIONALE | PROFESSIONAL SIDE MOWER

MOD : 160 | 180 | 200 | 220 | 240 | 260

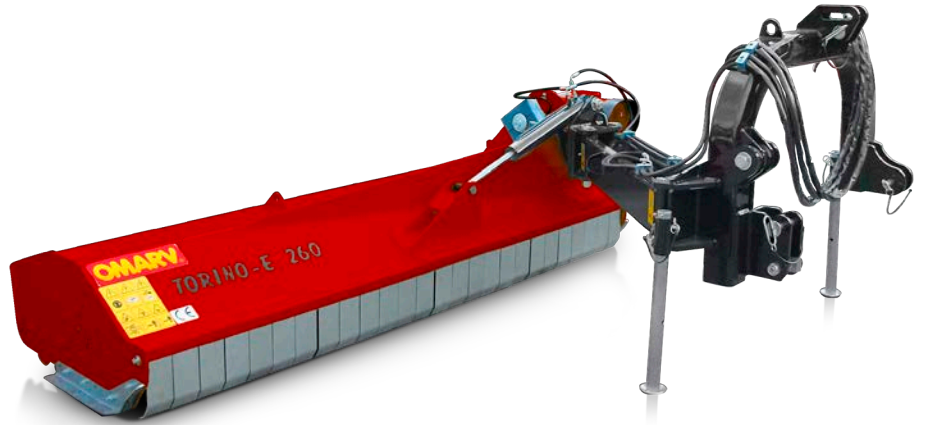
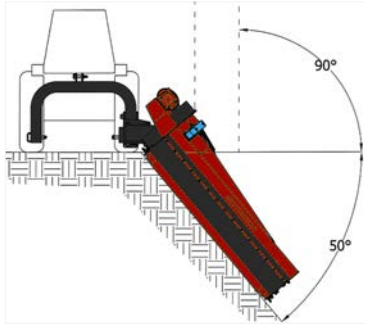

Ø 6-8 cm

CARATTERISTICHE | FEATURES



Utensili
Tools



Accumulatore oleopneumatico
Oleo-pneumatic accumulator



Gruppo esterno
External gearbox







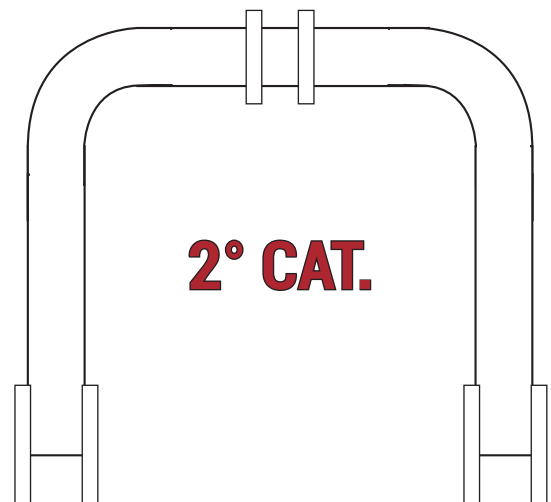

Rullo smontabile
Bolted roller

- Attacco terzo punto: cat. 2 | Type attelage: cat. 2
- Slitte laterali regolabili | Adjustable side skids
- Rullo autopulente regolabile e smontabile
Self-cleaning adjustable and bolted roller
- Tendicinghia automatico e ingrassaggio centralizzato
Centralised greaser and automatic belt tightener
- Gruppo moltiplicatore con ruota libera interna
Gearbox with free wheel
- Spostamento idraulico laterale con sistema di bloccaggio meccanico
Hydraulic side offset with mechanical stop system
- Ammortizzatore e accumulatore oleopneumatico
Oleo-pneumatic shock absorber and accumulator

ATTACCO TERZO PUNTO THREE POINT HITCH



SPECIFICHE TECNICHE | TECHNICAL SPECIFICATIONS

	MODELLO MODEL	160	180	200	220	240	260
	LARGHEZZA LAVORO WORK WIDTH (cm)	160	180	200	220	240	260
	LARGHEZZA MACCHINA WIDTH MACHINE (cm)	185	215	227	245	290	310
	PESO WEIGHT	870	900	930	960	1020	1050
	N° MARTELLI e COLTELLI HAMMER and KNIFE	34 68	38 76	44 88	48 96	52 104	56 112
	N° CINGHIE SPBX BELTS SPBX	4	4	4	4	5	5
	SCATOLA STANDARD STANDARD GEARBOX	65 -100		80-120		100-160	

	MODELLO MODEL	160	180	200	220	240	260
€	PREZZI PRICES	SU RICHIESTA ON REQUEST					

	RIF.	160	180	200	220	240	260
SPOSTAMENTO LATERALE (cm) SIDE OFFSET (cm)	A	160	180	200	220	240	260
	B	225	225	225	225	225	225
	C	30	30	30	30	30	30
	D	292	312	332	352	372	392
	E	220	220	220	220	220	220
	F	162	162	162	162	162	162

OPZIONI & ACCESSORI | OPTIONS & ACCESSORIES

CARDANO 1700 mm | PTO SHAFT 1700mm

CARDANO OMOCINETICO
WIDE ANGLE PTO SHAFT

CARDANO DOPPIO OMOCINETICO
HOMOCNETIC PTO SHAFT ON BOTH SIDES

VERSIONE SPOSTAMENTO SX | LEFT HAND SDE SHFT

CATENE PARASASSI | FRONT PROTECTION WITH CHAINS

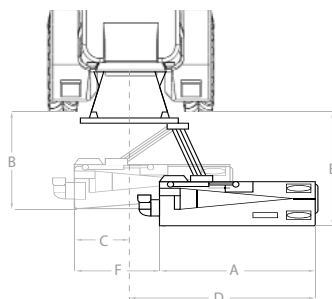

UTENSILI | TOOLS

MAZZA
HAMMER



COLTELLO A Y
Y FLAILS

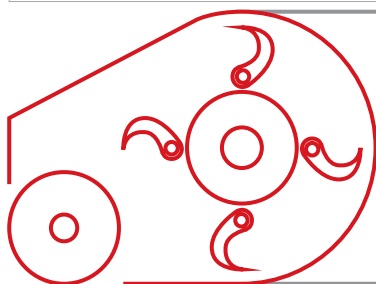

Ø del rotore Ø of rotor	180 mm
Giri rotore RPM	1800 g/min
Presenza di forza PTO	540
Ø del rullo Ø of roller	177 mm